

OWI INC

USER MANUAL

AMP-HD INSTALATION GUIDE FOR THE INCEILING, NEPTUNE, P602, INWALL AMPLIFIER

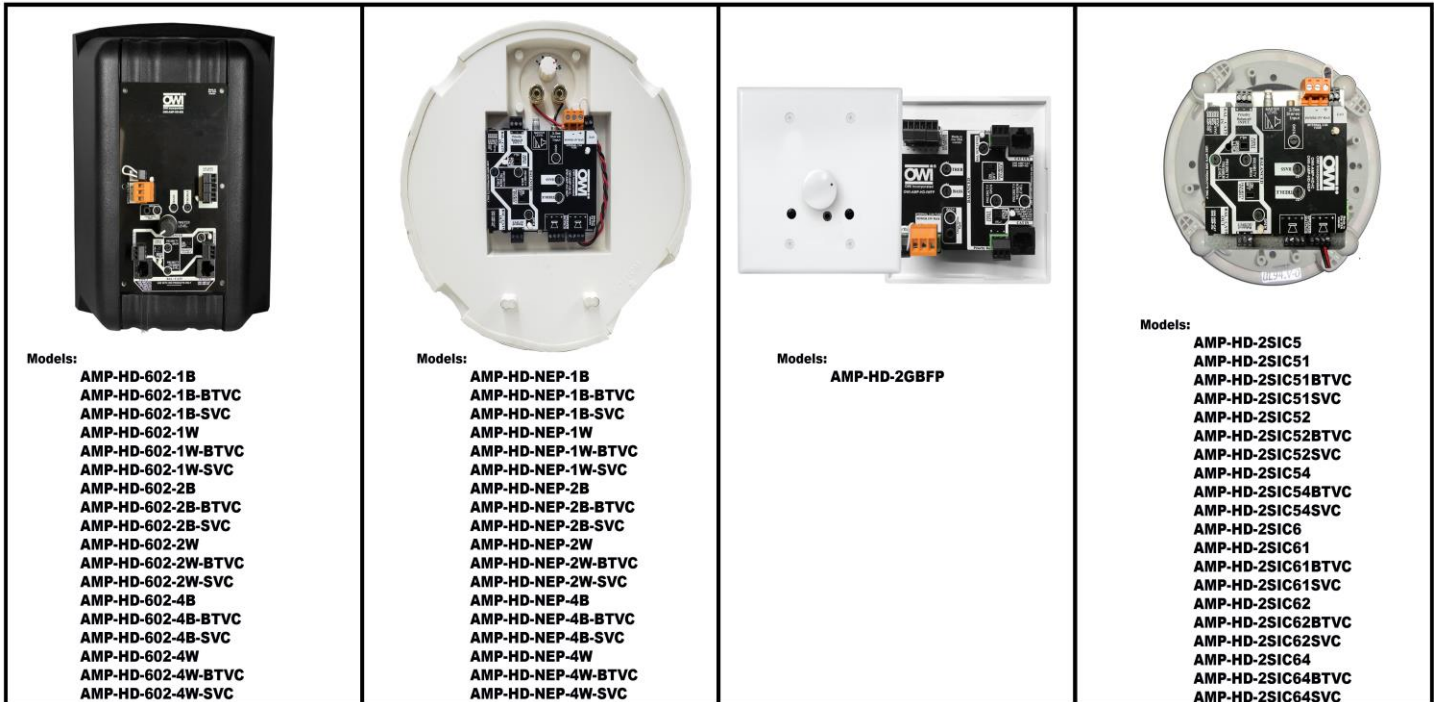

NOTE: This manual applies also to all the model names listed above.



OWI Incorporated
17141 Kingsview Ave. Carson CA 90746-1207 USA
Tel. 310-515-1900 Fax 310-515-1606

info@owi-inc.com
www.owi-inc.com

Technical Support 310-515-1900

OWI User Manual: Model AMP-HD Amplified Speaker Series

PROPRIETARY NOTICE

The OWI Inc. product information and design disclosed herein were originated by and are the property of OWI Inc. OWI Inc. reserves all patent, proprietary design, manufacturing, reproduction, use and sales rights thereto, and to any article disclosed therein, except to the extent right(s) are expressly granted to others.

COPYRIGHT NOTICE

This manual is Copyright 2014 by OWI Inc. All rights reserved. Reproduction in whole or in part without written prior permission from OWI, Inc. is prohibited.

UNPACKING AND INSPECTION NOTICE

Immediately upon receipt of the equipment, inspect the shipping container and the contents carefully for any discrepancies or damage. Should there be any, notify the freight company and OWI, Inc. or the dealer where purchased at once.

LIMITED WARRANTY

1. This product has been thoroughly tested and inspected at the factory. It is warranted for one year from the date of purchase.
IT IS THE OWNERS' RESPONSIBILITY TO ESTABLISH THE DATE OF PURCHASE BY ACCEPTABLE EVIDENCE AT TIME SERVICE IS SOUGHT.
2. Any unit, which in the judgment of OWI INC, is defective or develops defects under normal use will be replaced or repaired without cost within the warranty period.
3. This warranty will be considered void if the unit is dropped, misused, abused and altered in any manner, overdriven with excess amplification exceeding manufacturer's specification, improperly serviced or accidentally damaged.
4. OWI Inc. shall have no liability whatsoever for consequential damages. The sole responsibility at the discretion of OWI Inc. under this warranty shall be limited to the repair of the product or replacement thereof. Any and all implied warranties including the implied warranty of merchantability are limited to the duration of this express limited warranty.
OWI, Inc. is NOT liable for incidental or consequential damages of any kind.
5. IMPORTANT: This warranty is void unless the attached card is completed and mailed to OWI Inc. within 10 days following the date of purchase. Units must be sent to OWI Inc. or to the dealer where purchased.

RETURN SHIPPING INSTRUCTIONS, Obtain a RETURN AUTHORIZATION from:

OWI Inc., 17141 Kingsview Ave, Carson, CA 90746.

Phone (310) 515-1900, Fax (310) 515-1606

FCC Notice: This equipment has been tested and found to comply with the limits for a Class A digital device, pursuant to part 15 of the FCC Rules. These limits are designed to provide reasonable protection against harmful interference when the equipment is operated in a commercial environment. This equipment generates, uses, and can radiate radio frequency energy and, if not installed and used in accordance with the instruction manual, may cause harmful interference to radio communications. Operation of this equipment in a residential area is likely to cause harmful interference in which case the user will be required to correct the interference at his or own expense.

Modifications not expressly approved by the manufacturer could void the user's authority to be operated under FCC rules.

Table of Contents

Description	Page
Proprietary, Copyright Notices	2
Unpacking and Inspection	2
Warranty Information	2
Return Shipping Instructions	2
Table of Contents	3
Important Safety Instructions	4 - 5
Introduction	6
Specifications	7 - 8
Illustration: Connection and Control	9-11
Chained Self Amplified Speakers Wiring	12-14
One, Two, Four Speaker Combination Wiring	15-22
Input Connectors Wiring	15-22
AMP-HD Wiring Diagram	15-22
HD AMP Integration to 25/70 volt transformer	22
Volume Control Wiring Diagram	22
25/70/100 volt line integration from paging systems	22
Installation	22
Warranty	23
Back Cover	24

OWI User Manual: Model AMP-HD Amplified Speaker Series
IMPORTANT SAFETY INSTRUCTIONS

CAUTION



RISK OF ELECTRIC SHOCK - DO NOT OPEN



NOTE: Installation is to be completed by a qualified electrical technician according to NEC/CEC code and applicable local codes.

CAUTION: The power supply is not to be used in air handling spaces.

CAUTION: To reduce the risk of electric shock: Do not remove the cover or back: No user-serviceable parts inside: refer servicing to qualified personnel.

The lightning flash with arrowhead within an equilateral triangle is intended to alert the user to the presence of uninsulated “dangerous voltage” within the product’s enclosure that may be of sufficient magnitude to constitute a risk of electric shock to persons.

The exclamation point within an equilateral triangle is intended to alert the user of the presence of important operating and maintenance (servicing) instructions in the literature accompanying the appliance.

The apparatus shall not be exposed to dripping or splashing and that no objects filled with liquids, such as vases, shall be placed on the apparatus.

IMPORTANT SAFETY INSTRUCTIONS

1. Read these instructions. All the safety and operation instructions should be read before this OWI product is operated.
2. Keep these instructions - The safety and operating instructions should be kept for future reference.
3. Heed all warnings - All warnings on this product and in these operating instructions should be followed.
4. Follow all instructions - All operating and other instructions should be followed.
5. Do not use this apparatus near water - for example, near a bathtub, washbowl, kitchen sink, laundry tub, in a wet basement, near a swimming pool, or a swamp.
6. Clean only with dry cloth.
7. Do not block any ventilation openings. Install in accordance with the manufacturer’s instructions. - This OWI product should be situated so that its location or position does not interfere with its proper ventilation. For example, the component should not be situated on a bed, sofa, rug, or similar surface that may block any ventilation openings, or placed in a built-in installation such as a bookcase or cabinet that may impede the flow of air through ventilation openings.
8. Do not install the unit near any heat sources such as radiators, heat registers, stoves or other apparatus (including amplifiers) that produce heat.
9. Do not defeat the safety purpose of the polarized or grounding-type plug. A polarized plug has two blades with one wider than the other. A grounding type plug has two blades and a third grounding

prong. The wider blade or the third prong is provided for your safety. If the provided plug does not fit into your outlet, consult an electrician for replacement of the obsolete outlet.

10. Protect the power cord from being walked on or pinched particularly at plugs, convenience receptacles, and the point where they exit the apparatus.
11. Only use attachment/accessories specified by the manufacturers.



Portable Cart Warning

12. Use only with the cart, stand, tripod, bracket or table specified by the manufacturer, or sold with the apparatus. When a cart is used, use caution when moving the cart/apparatus combination to avoid injury from tip-over.
13. Unplug this apparatus during lightning storms or when unused for long periods of time.
14. Refer all servicing to qualified service personnel. Servicing is required when the apparatus has been damaged in any way, such as power-supply cord or plug is damaged, liquid has been spilled or objects have fallen into the apparatus, the apparatus has been exposed to rain or moisture, does not operate normally, or has been dropped. The user should not attempt to service this OWI product beyond those means described in this operating manual. All other servicing should be referred to the OWI Service Department.
15. **WARNING:** To reduce the risk of fire or electric shock, do not expose this apparatus to rain or moisture.
16. To prevent electric shock, do not use this polarized plug with an extension cord, receptacle or other outlet unless the blades can fully be inserted to prevent blade exposure.
17. Exposure to extremely high noise levels may cause permanent hearing loss. Individuals vary considerably in susceptibility to noise-induced hearing loss, but nearly everyone will lose some hearing if exposed to sufficiently intense noise for a period of time. The U.S. Government's Occupational Safety and Health Administration (OSHA) has specified the permissible noise level exposures shown in the following chart. According to OSHA, any exposure in excess of these permissible limits could result in some hearing loss. To ensure against potentially dangerous exposure to high sound pressure levels, it is recommended that all persons exposed to equipment capable of producing high sound pressure levels use hearing protectors while the equipment is in operation. Ear plugs or protectors in the ear canals or over the ears must be worn when operating the equipment in order to prevent a permanent hearing loss if exposure is in excess of the limits set forth here.
18. OWI recommends that this apparatus be placed on a switched power outlet, one that switches both sides and has contact separation of at least 3 millimeters.

End of IMPORTANT SAFETY INSTRUCTIONS

OWI User Manual: Model AMP-HD Amplified Speaker Series

Introduction

The OWI **AMP-HD AMPLIFIER** is a three source integratable self-powered speaker/amplifier. This amplifier can drive Four (4) - 8ohm speakers connected parallel. With an included UL Listed, **Level 5** (Energy Star), 15-volt, 3.5 ampere power supply, the amplifier can output 40 watts, or 10 watts per speaker in a four-speaker hook-up.

Special features of the OWI AMP-HD AMPLIFIER include:

Three (3) audio inputs: Stereo 3.5 Mini Jack Line Input, Balanced Line Input, proprietary Cat 5 input for OWI Products only

Input # 1 Stereo 3.5 Mini Jack Line Input - The JACK LINE IN accepts unbalanced input via 3.5 mini jack. The stereo channels are summed together. This input is muted when the Priority Override is in use.

Input # 2 Balanced Line Input -The **LINE IN** inputs accepts a balanced input via a Phoenix style screw terminal plug. This also is and has the **Priority Override Feature connected to it**. - The **Priority** input accepts balanced input levels 1-volt (approximately line level) audio and Speaker level at 1 watt or less. Audio on the **Priority** input suspends audio on the **3.5 mini jack and Cat 5 Inputs** and switches the speaker amplifier to pass the **Priority** audio. After the **Priority** audio stops, the unit waits before returning to the **Line In and Jack Line In** audio input.

Input # 3 Cat 5 input - Proprietary Cat 5 input for OWI Products only.

Use only with another OWI AMP-HD or HD AMP SPEAKER, OWI MC4, OWI BTVC, AMPSTVCW and Future OWI models.

Priority Override Paging (POP) – The POP controls are the POP Trigger level and the POP Volume level

POP Volume Level – The POP Volume level is the level at which the speaker will play the POP Message. This level can be set from Zero to MAX

POP Trigger Level – Adjust this by rotating it from more to less sensitive. If this is too low it will not trigger the controller to switch. If it is set too high it will constantly stay on and not go back to the needed setting.

Switches

POP / ALL SOURCES MIXED SWITCH – When the amplifier is going to be used in a Priority Override mode place the switch to the Priority Override

Line Level/Speaker Level Switch – This is for the Priority Override input #2

Balanced Line Level Output

OUTPUT # 1 A nominal 0dB level, balanced output is available at LINE OUT. The source of this output is a balanced Line Output via a Phoenix style screw terminal plug.

OUTPUT # 2 - Cat 5 output - Proprietary Cat 5 output for connecting or stacking another OWI AMP speaker. This carries both the power and the signal to the next amplifier.

Power Amplifier Features

The power amplifier outputs **2 times 20 watts or 40 watts total into 8 ohms** and 15VDC power. The class D power amplifier has reduced radiated electromagnetic interference (EMI) due to a special feature of the power amplifier, operating in a patented spread spectrum. The power amplifier protects itself from over-temperature, over-current, over-voltage conditions. The power amplifier will shut itself down during these conditions.

IMPORTANT NOTE! This amplifier is intended for audio use only! Continuous sine wave drive into a load will cause the amplifier to shut itself down when it heats up.

SPECIFICATIONS (MODEL AMP-HD-AMP)

ELECTRICAL AMPLIFIER	SPECIFICATIONS
	AMP-HD
Input voltage, nominal	(25 watts) 15 volts DC
Input current, operating (15VDC)	1.45 amperes peak
Input volt-amperes, peak (15VDC)	22 volt-amperes
Input voltage, maximum	16.5 volts, DC
Frequency Response,	
EQ set to flat	20Hz to 20 kHz
Bass	±10dB@50Hz
Treble	±10dB@10kHz
THD + Noise	<1% at 13.5 watts, "A" weighted
S/N	>82 dB
Max Power Output (28V in)	40 watts
DC Power, Standby	1.4 watts
AC Power, Sleep Mode	1.4 watts
DC Power,	
Short Circuit protected	Yes
Over current protected	Yes
Over voltage protected	Yes
Over temperature protected	Yes
Minimum Load Impedance	4.0 Ω (Two 8 Ω Speakers in parallel)
Minimum Input impedance, Priority in	10,000 Ω
Minimum Input impedance, RJ45 in	150,000 Ω
Minimum Input impedance, mini-jack	37,000 Ω
Warranty	1 year

POWER SUPPLY

PS15VDC35AL5	SPECIFICATIONS
Input	100 to 240 VAC, 50-60 Hz, 1.4A Note: Be sure to use the correct polarity on the power input.
Output	15 VDC, 3.5 amperes
Wire gauge and length	Minimum 18 gauge up to 40 feet maximum length
Electrical, Power Supply	UL Listed, Level 5 (Energy Star)
Weight	0.45 pounds
Size	4.7"H x 2"W x 1.2"D

CAUTION: The Power Supply is not to be used in air handling spaces.

**Note: Maximum power requires the replacement of the 15 volt supply with a 22 volt supply and Energy Star and UL approvals no longer apply.*

Power Supply Wire Gauge and Length - Minimum 18 gauge up to 40 feet maximum length

PS15VDC35AL5 Grounding Illustration



OWI User Manual: Model AMP-HD Amplified Speaker Series

NON-AMPLIFIED SPEAKER	SPECS	SPECS	SPECS	SPECS	SPECS
MODEL #	IC6	NEPTUNE	P602	TRUMPET	INWALL AMP
DESCRIPTION:	6.5", 2-way, coaxial	5", 5-way, - 2-way 4 tweeters	6.5", 2-way,	4"	N/A
IMPEDANCE:	8 ohms	8 ohms/ 70 VOLT	4 ohms	4 ohms/ 70 VOLT	N/A
SENSITIVITY (1W/1M):	86 dB	88 dB	83 dB	88 dB	N/A
DISPERSION:	120 degrees	360 X 180 degrees	120 degrees	120 X 90 degrees	N/A
MAX POWER (8 Ohms)	50 watts	100 watts	60 watts	60 watts	N/A
NOMINAL POWER (8 Ohms)	25 watts	50 watts	35 watts	30 watts	N/A
FREQUENCY RESPONSE:	65Hz ~ 20 kHz	80Hz ~ 20 kHz	80Hz ~ 20 kHz	140Hz ~ 20 kHz	N/A
WOOFER SIZE:	6.5"	5"	6.5"	4"	N/A
WOOFER MATERIAL:	Paper, PP coated	Paper, PP coated	Paper, PP coated	Paper, PP coated	N/A
TWEETER SIZE:	0.5"	1" x 4 each	0.5"	N/A	N/A
TWEETER MATERIAL:	PEI	PEI	PEI		N/A
GRILL MATERIAL:	Aluminum	Aluminum	Aluminum	Aluminum	N/A
OVERALL DIMENSIONS (Diameter X Height):	Φ8.93*3.45	9.75 x 9.75 x 7.5	9.5 x 8.5 x 11.25	5.9 x 9.8 x 10	
WEIGHT: lbs.	2.5	6.5	12	7	
MOUNTING HARDWARE:	Mounting Clamps	Housing & Screws	U Bracket	U bracket	

End of Specifications

Illustration: Connection and Control AMP-HD-602

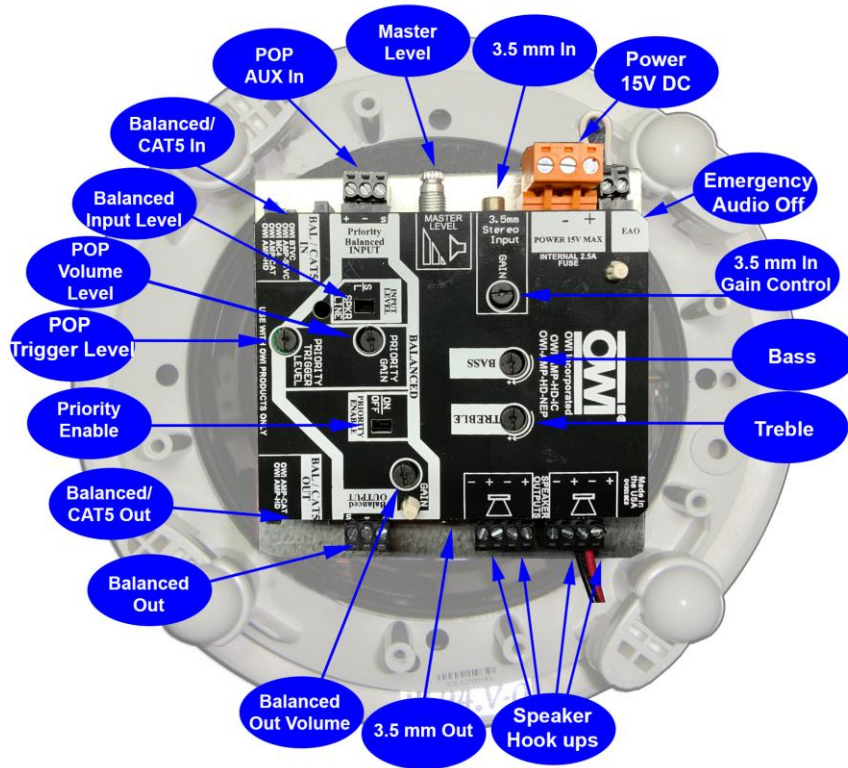
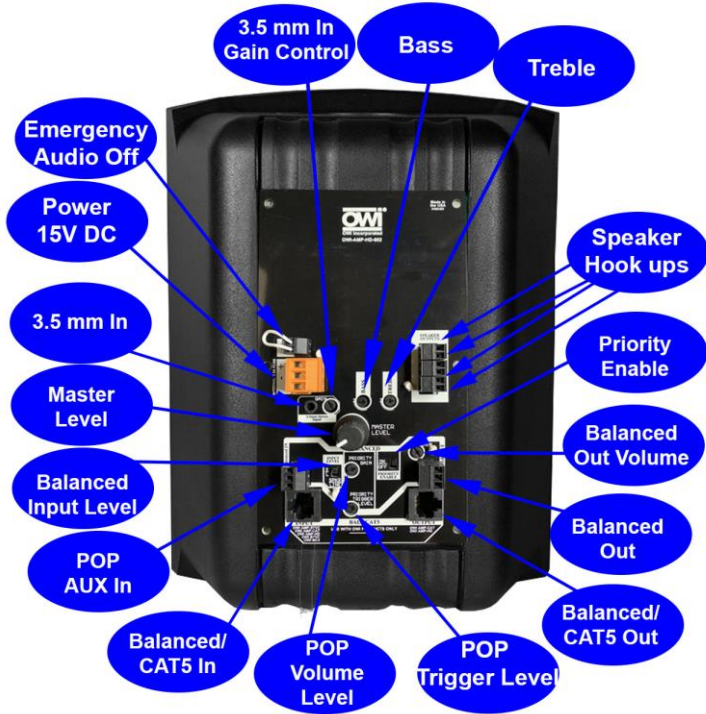

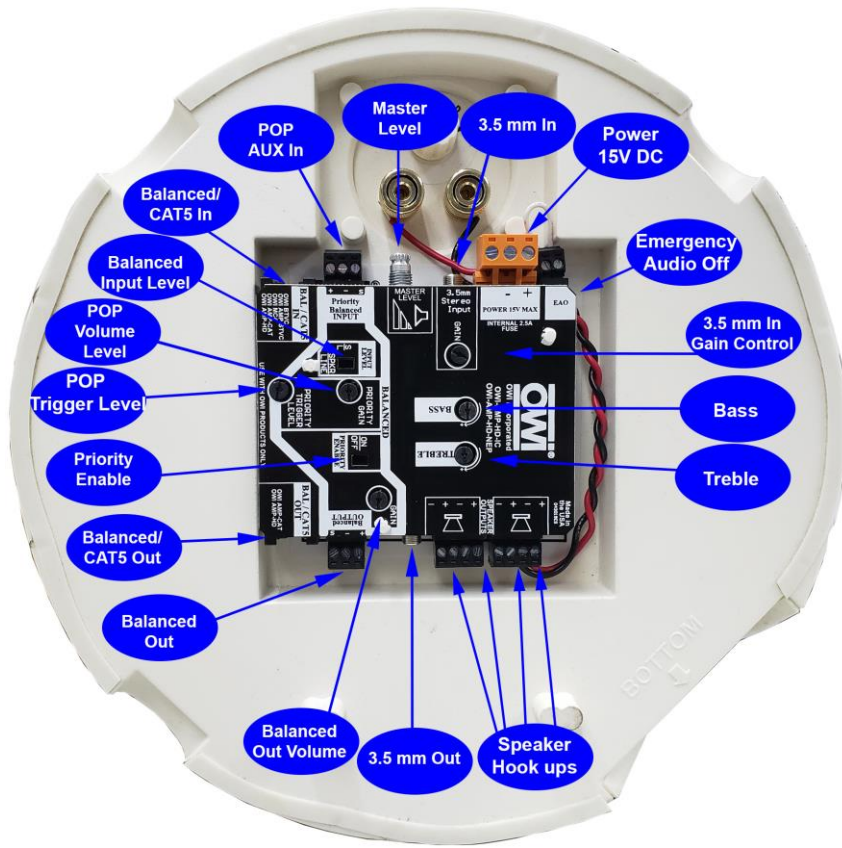

OWI User Manual: Model AMP-HD Amplified Speaker Series

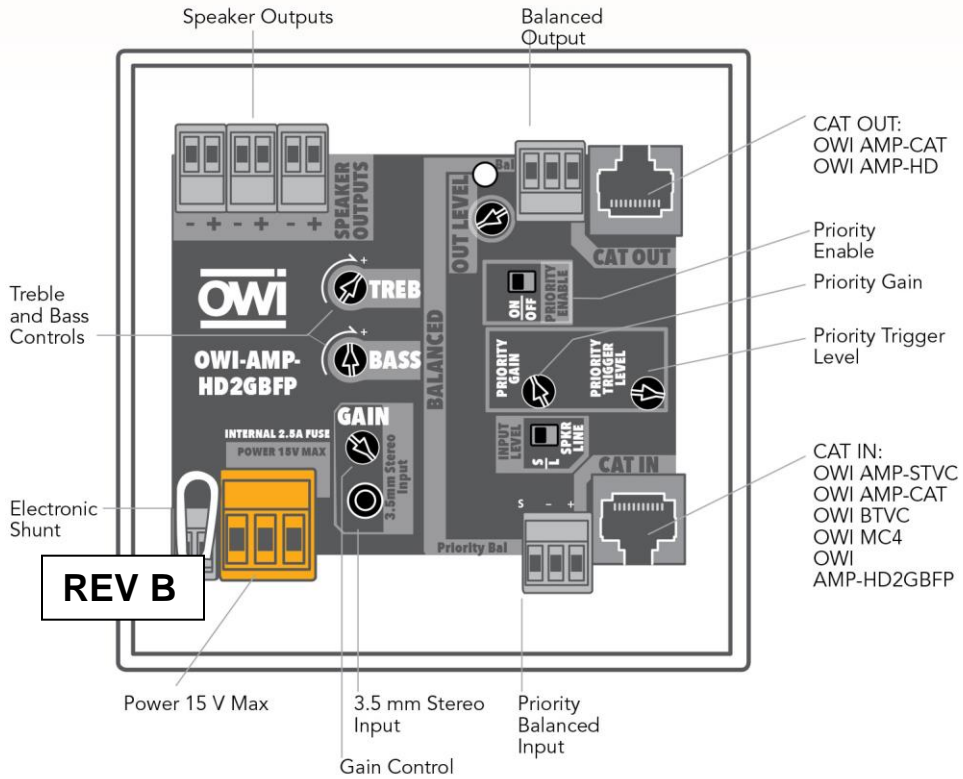
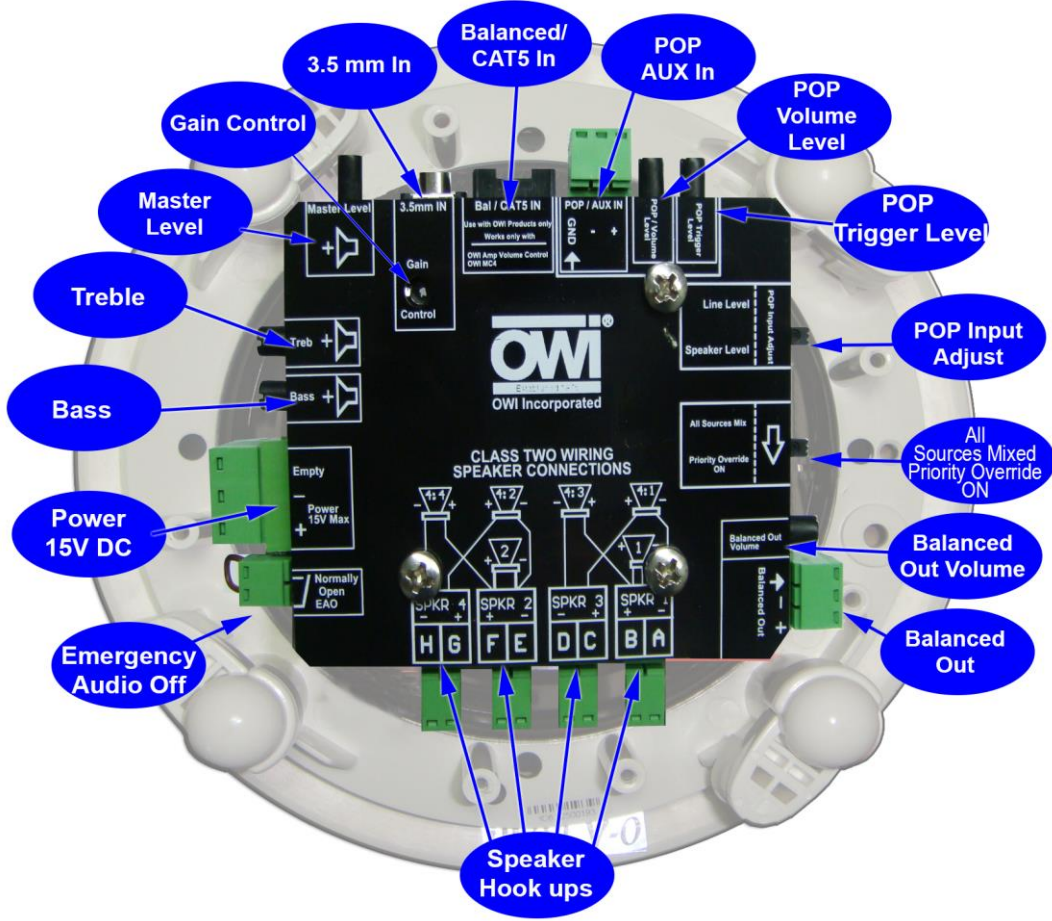

**AMP-HD TO ANOTHER AMP-HD VIA CAT-5
SPEAKER WIRING SINGLE LINE DIAGRAM
Chained Self Amplified Speakers Wiring VIA CAT-5 cable
The CAT-5 carries the signal and the power**

To add more Amplified Speakers, connect the output of the Amplified Speakers to the input of the next Amplified Speaker

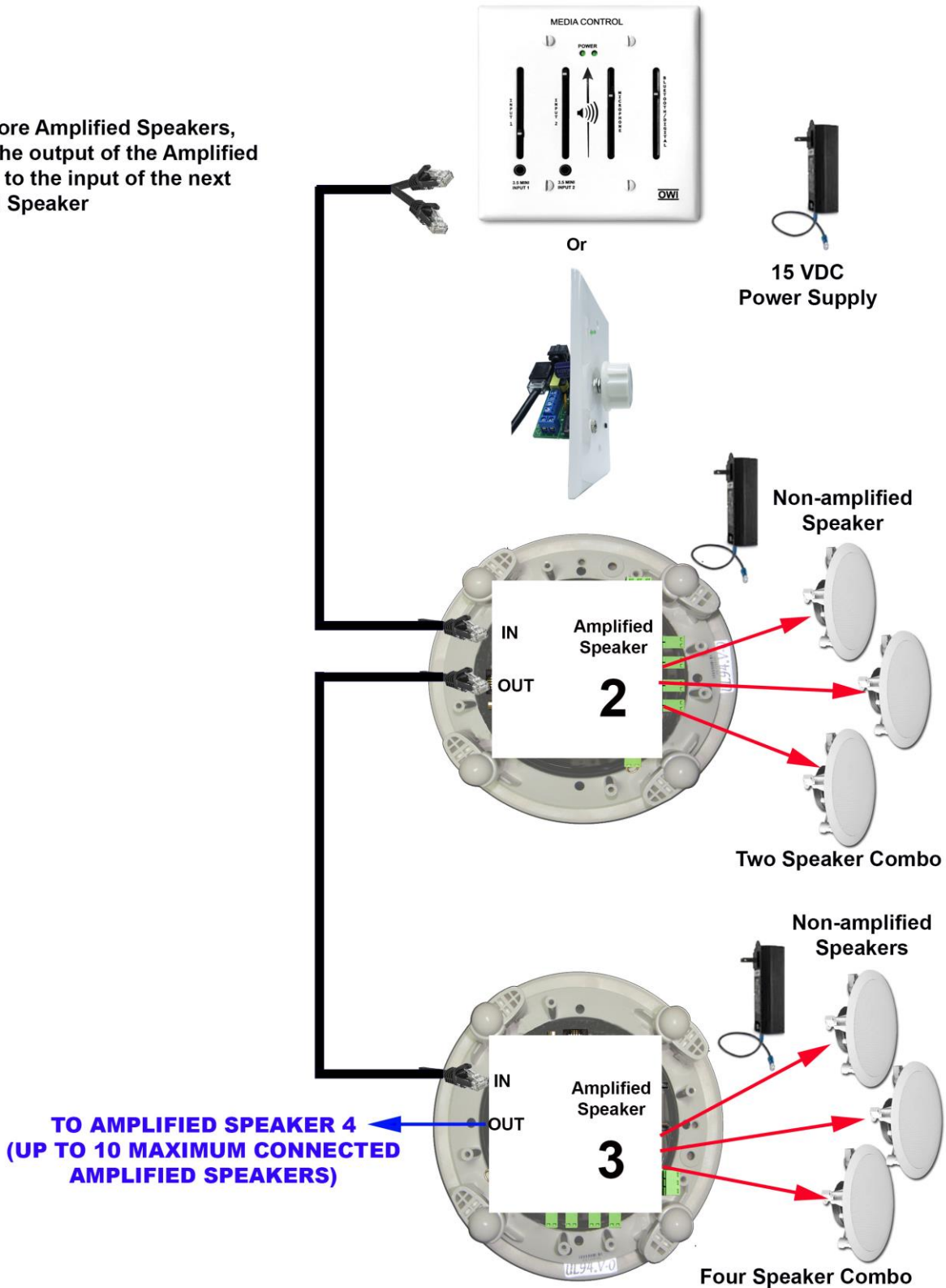

To add more Amplified Speakers, connect the output of the Amplified Speakers to the input of the next Amplified Speaker

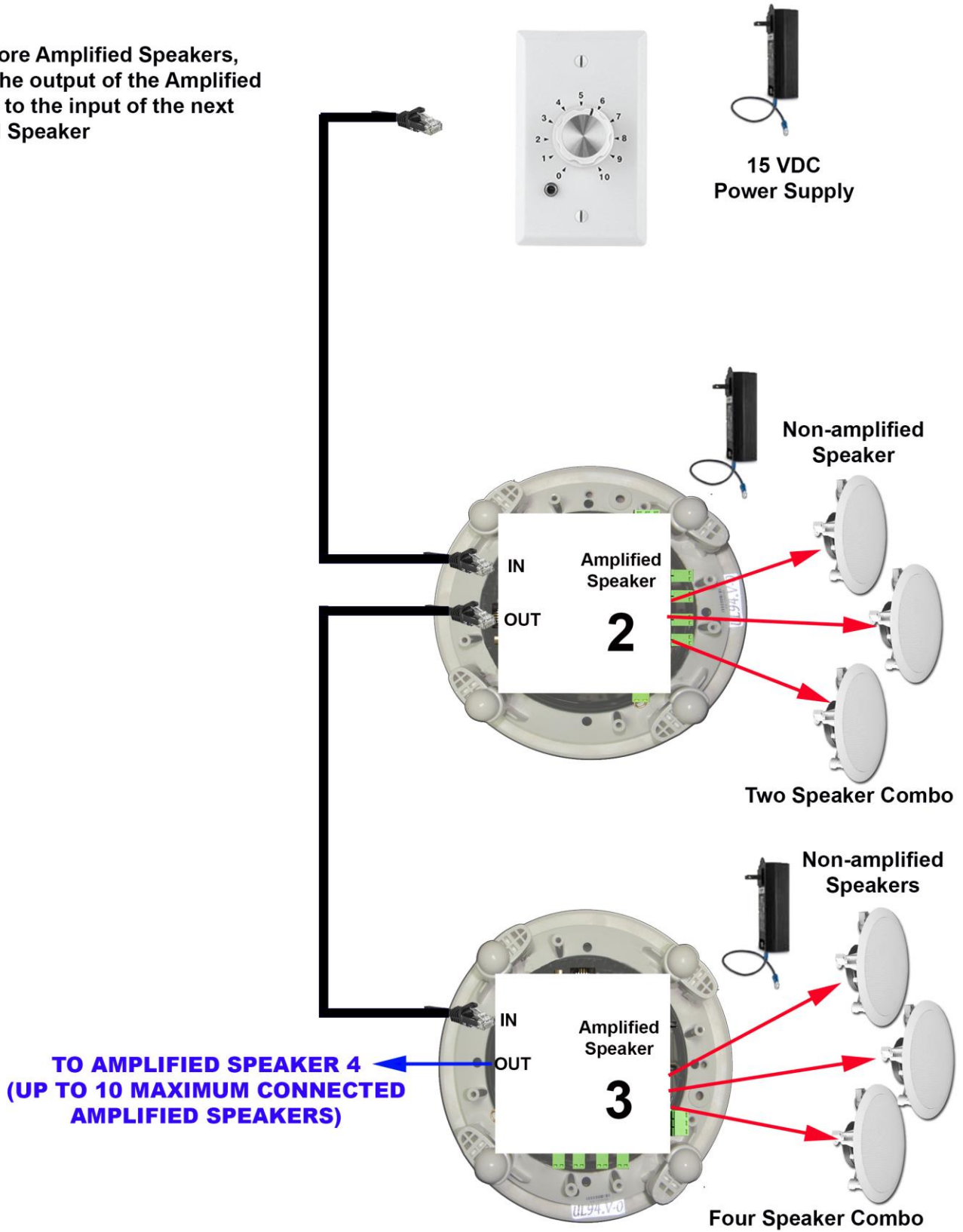

110116

**AMP-HD TO ANOTHER AMP-HD VIA BALANCED LINE OUT
SPEAKER WIRING SINGLE LINE DIAGRAM
Chained Self Amplified Speakers Wiring**

*You will need to run a separate power supply if you are running balanced cables only

Chained Self Amplified Speakers Wiring

To add more Amplified Speakers, connect the output of the Amplified Speakers to the input of the next Amplified Speaker

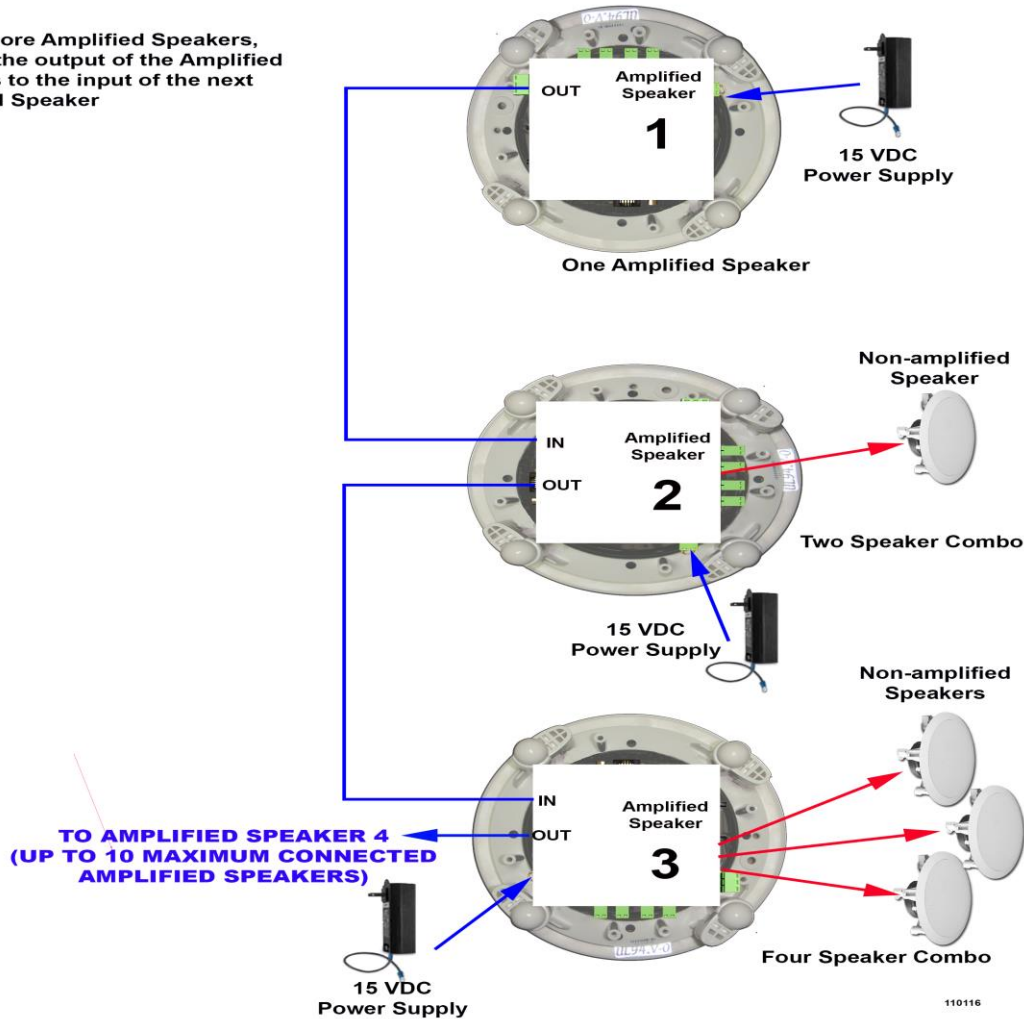

One, Two, Four Speaker Combination Wiring

AMPLIFIED SPEAKER TO NON-AMPLIFIED SPEAKER HOOK UPS

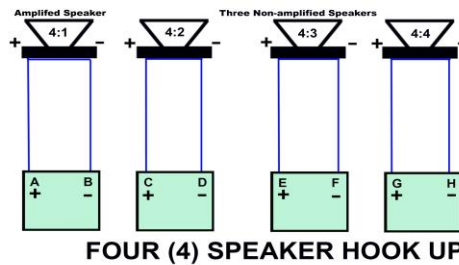
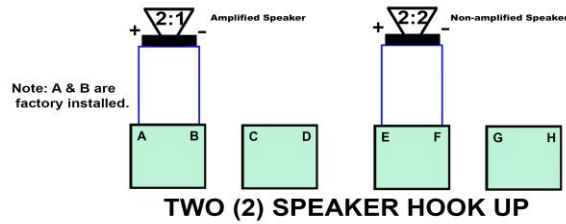
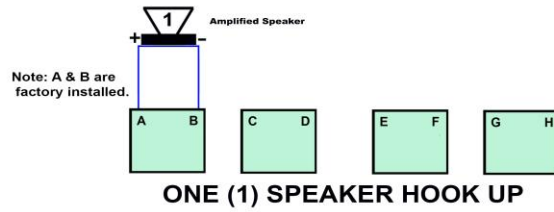

INPUT CONNECTORS WIRING

Note: Jack Line In is the same as STEREO LINE IN, immediately below.

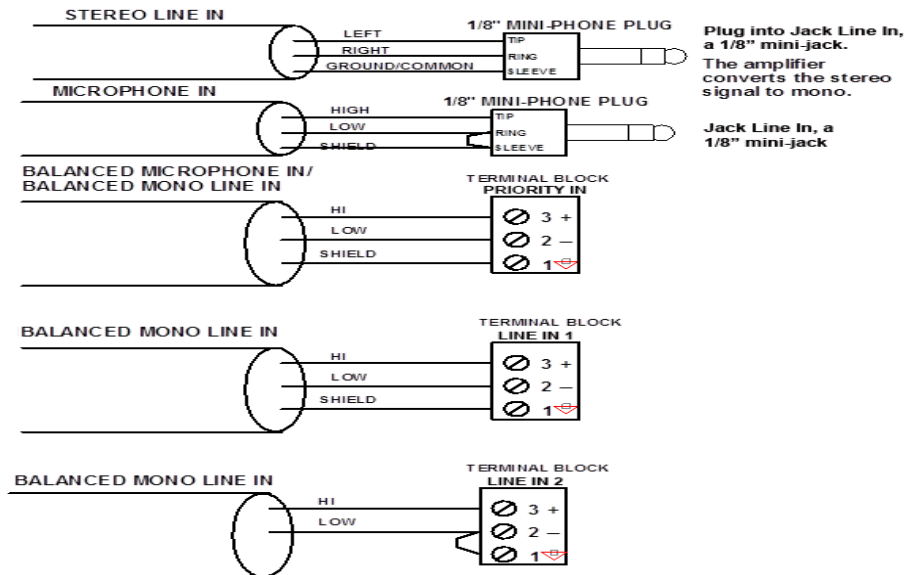

OWI AMP-HD-602 WIRING DIAGRAM

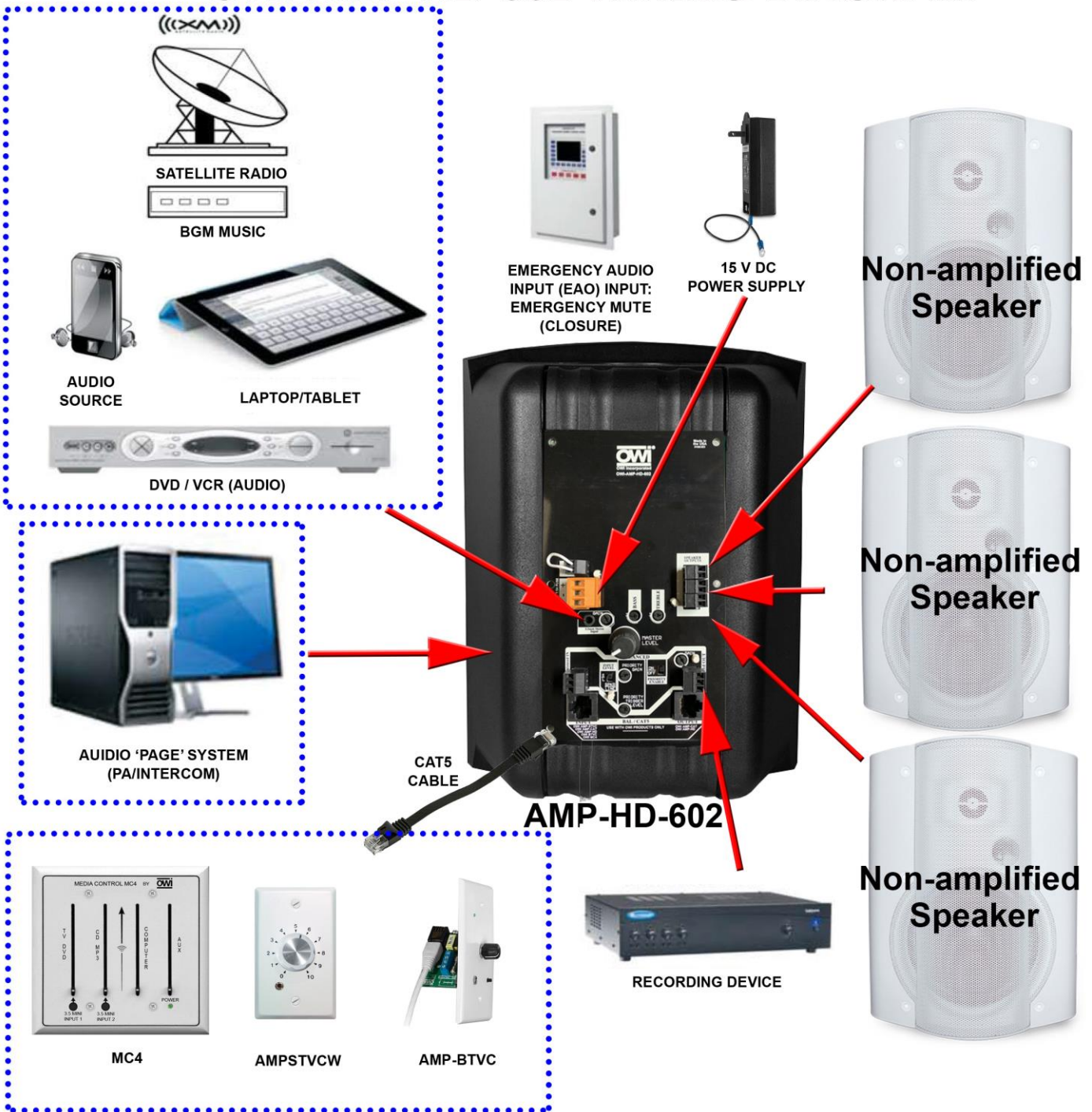

CAT5 Cable to input of the amplifier

OWI® OWI Incorporated
17141 Kingsview Ave.
Carson, CA 90746
310-515-1900
www.owi-inc.com

OWI AMP-HD WIRING DIAGRAM

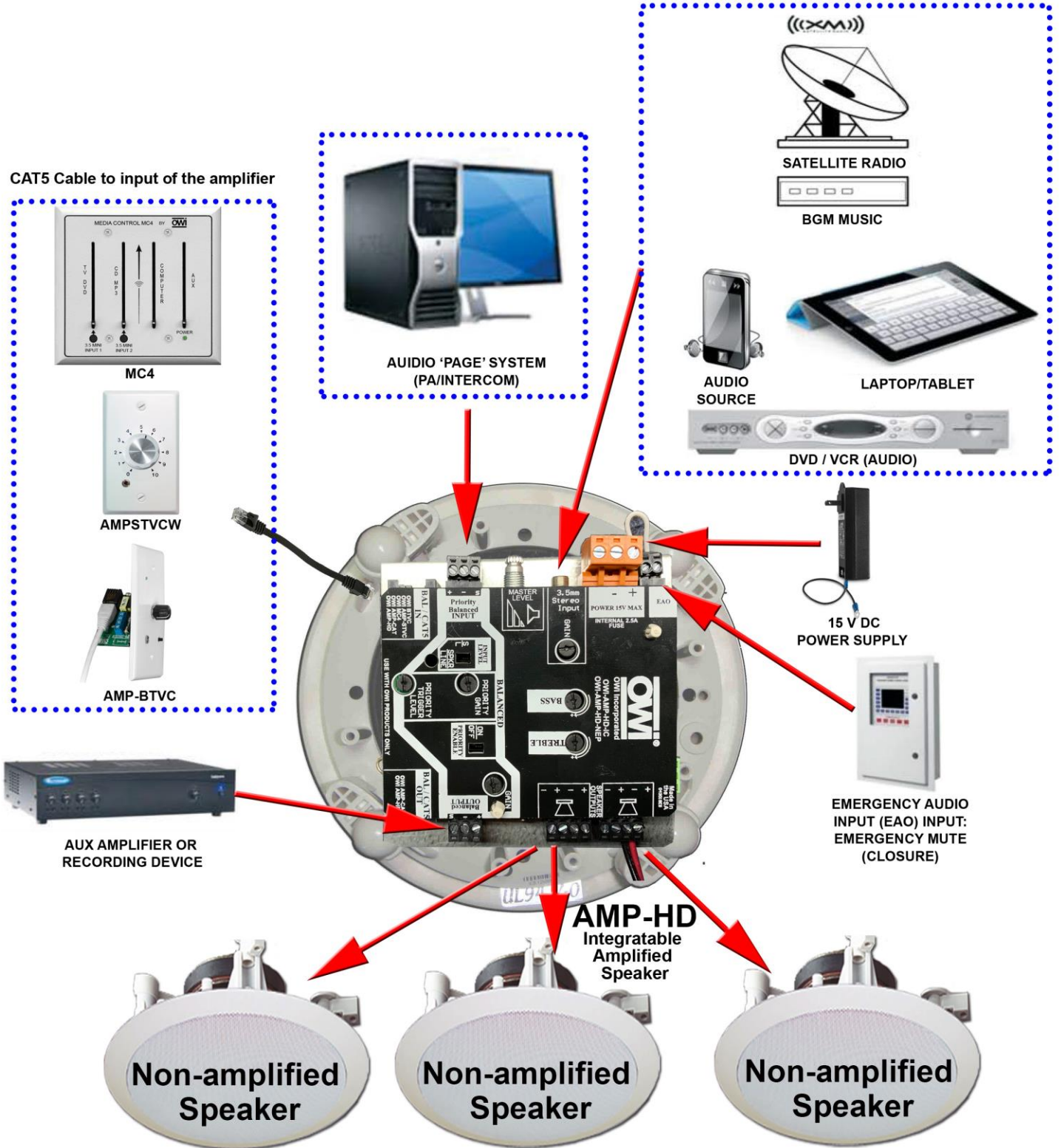

OWI® OWI Incorporated
 17141 Kingsview Ave.
 Carson, CA 90746
 310-515-1900
 www.owi-inc.com

OWI AMP-HD-2GBFP WIRING DIAGRAM

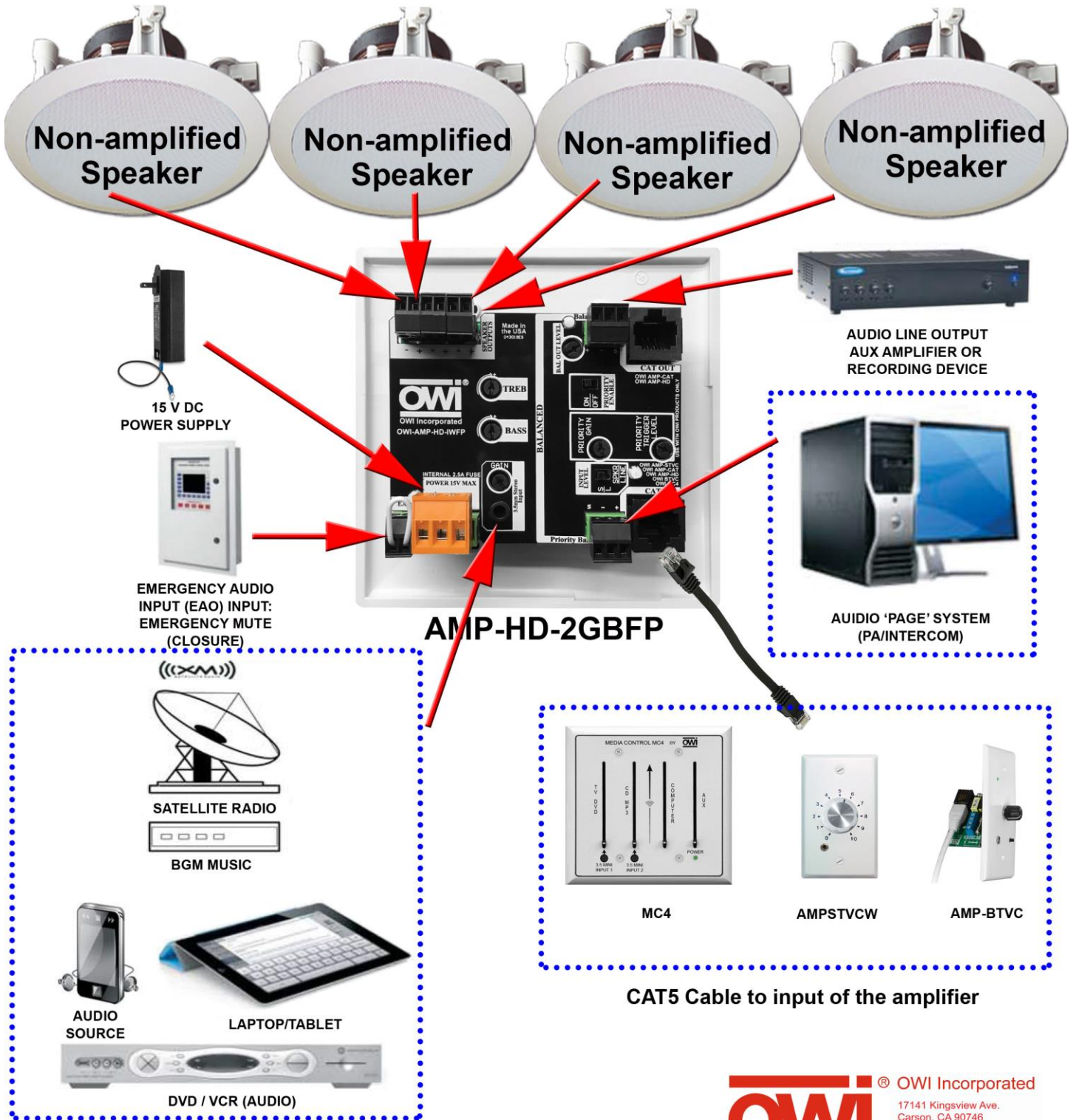

OWI® OWI Incorporated
 17141 Kingsview Ave.
 Carson, CA 90746
 310-515-1900
www.owi-inc.com

OWI AMP-HD WIRING DIAGRAM

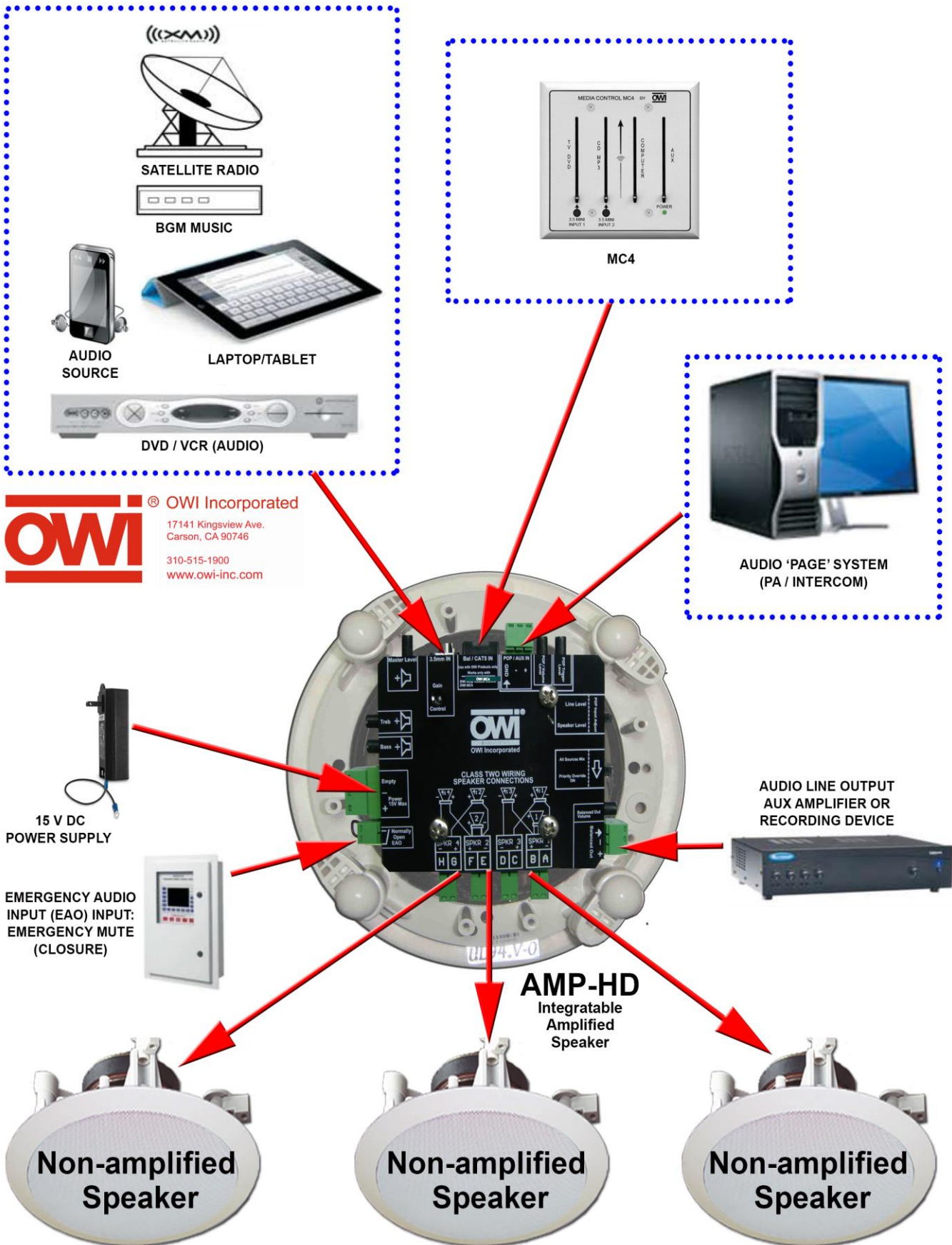

OWI® OWI Incorporated
 17141 Kingsview Ave.
 Carson, CA 90746
 310-515-1900
 www.owi-inc.com

OWI AMP-HD WIRING DIAGRAM

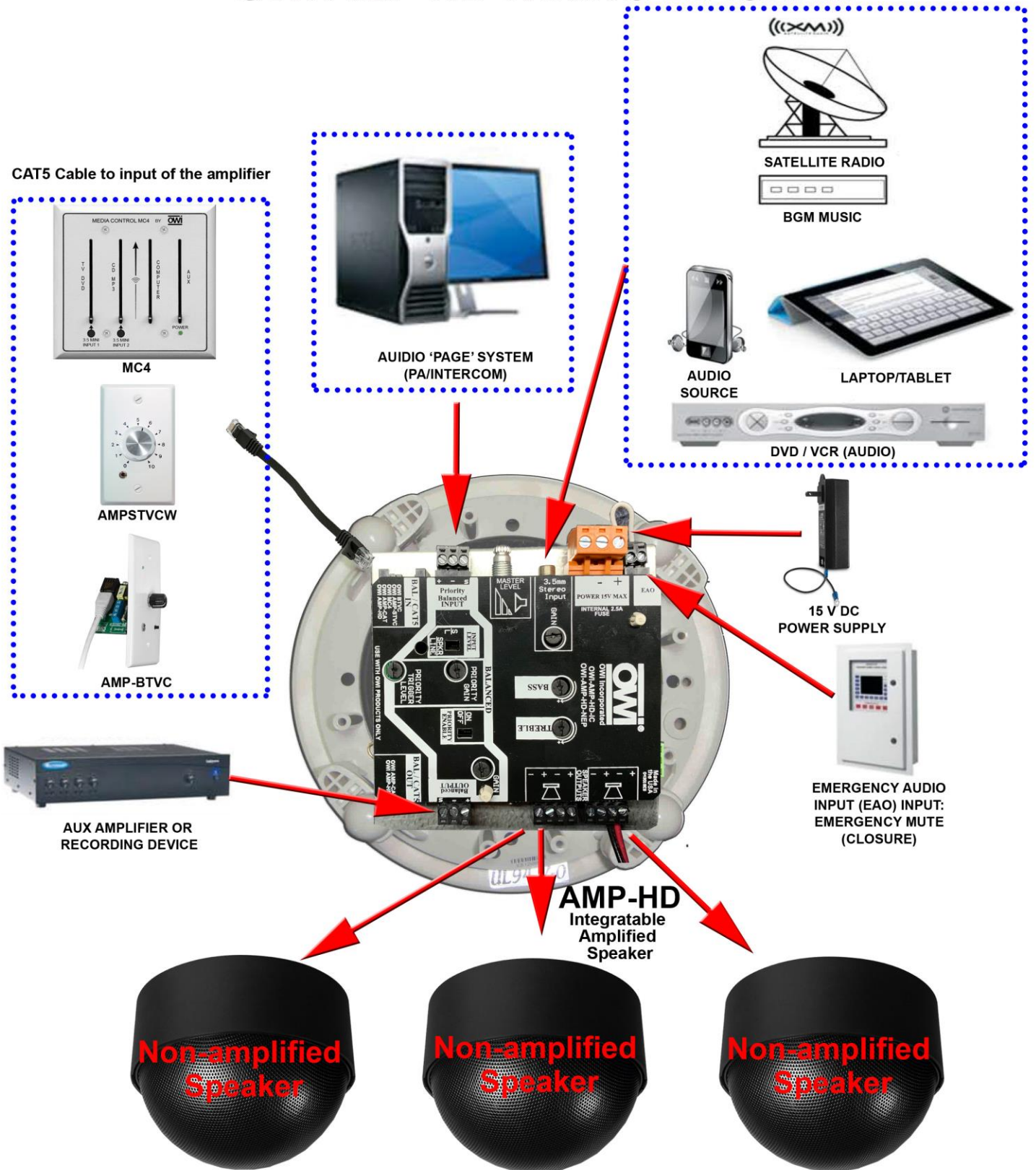

OWI® OWI Incorporated
 17141 Kingsview Ave.
 Carson, CA 90746
 310-515-1900
 www.owi-inc.com

VOLUME CONTROL WIRING DIAGRAM



MODEL AMP-BTVC
Bluetooth Volume Control

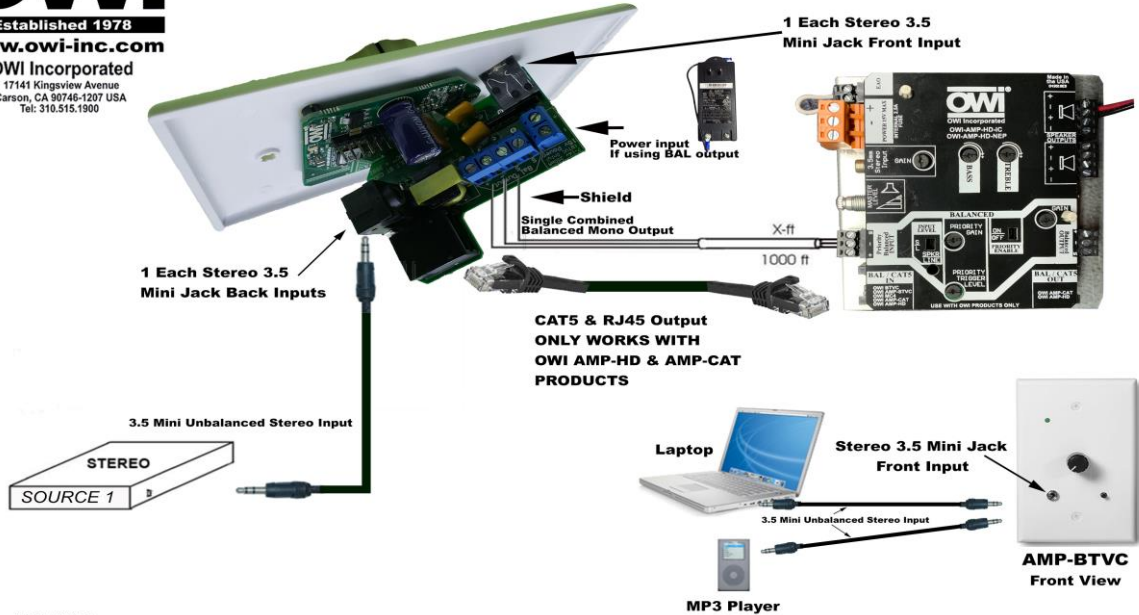

AMP-BTVC
Two Channel
Two Stereo Combiners
Bluetooth
Transformer Balanced

Note: To avoid ground loops, use only plastic single gang boxes.

BLUETOOTH VOLUME CONTROL WIRING DIAGRAM

10/31/19



MODEL AMPSTVCW
Stereo/Mono Mixer Volume Control

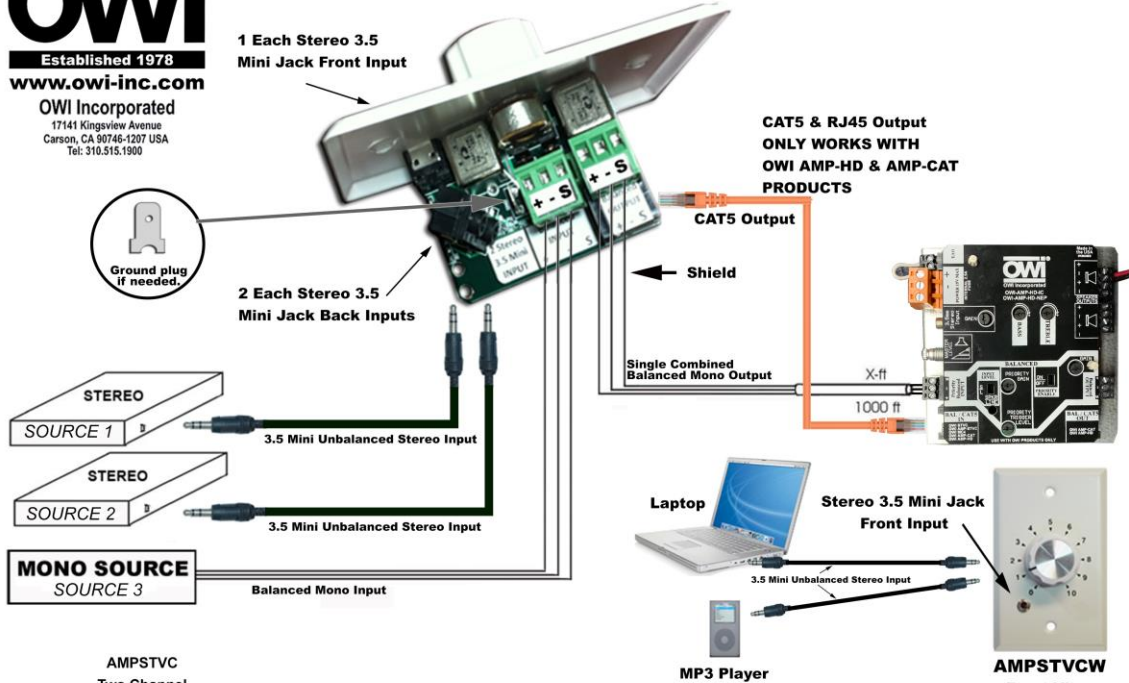

AMPSTVCW
Two Channel
Two Stereo Combiners
Takes Stereo Converts to Mono
Transformer Balanced

Note: To avoid ground loops, use only plastic single gang boxes.

STEREO/MONO VOLUME CONTROL WIRING DIAGRAM

09/17/15

For projects requiring integration with 25/70/100-Volt line from paging systems:

1. Transformer will be wired from the factory with the Ohm leads connected to the Priority Override Page (POP) Balanced Input and the selector switch positioned to SPK LVL (Speaker Level)
2. Connect 25/70/100-volt line to 1/2W – 1W tap setting

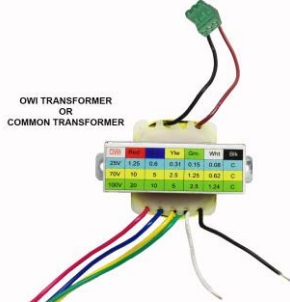

See diagram:

3. Adjust volume to adequate level before distortion to sound the speaker or to lowest volume (spinning to left) to mute speaker.
4. Adjust the trim to activate the override feature sensitivity.

INSTALLATION

NOTE: Installation is to be completed by a qualified electrical technician according to NEC/CEC code and applicable local codes.

Speaker Placement

Before installing your OWI speakers, consider the placement carefully, taking into effect the location of electrical, plumbing and other fixtures.

Placement On the Wall or Ceiling

OWI speakers should be located at the primary listening area.

Mounting your OWI speakers

Determine the best area to mount your OWI speakers. It will be necessary to run your speaker wires to that location. This location must be free of obstructions, such as electrical conduits, HVAC ducts, or water lines.

Route the speaker wires from your amplifier to your opening. Avoid routing the speaker wire near electrical wires. If you have to run them parallel, make certain to space the speaker wires at least 2 feet from the AC line. Do not nail or staple the speaker wire.

Prepare Your OWI Speakers for Mounting

OWI SPEAKER SYSTEM LIMITED WARRANTY REGISTRATION

(Save this portion for your records)

1. Your OWI Speaker System has been thoroughly tested and inspected at the factory. It is warranted for 1 year from date of purchase.
IT IS THE OWNERS' RESPONSIBILITY TO ESTABLISH THE DATE OF PURCHASE BY ACCEPTABLE EVIDENCE AT TIME SERVICE IS SOUGHT.
2. WHAT WE WILL PAY FOR AND WHAT YOU MUST PAY FOR:
OWI INC. will repair or replace unit(s) covered by this warranty, without charge to the consumer for labor or materials. YOU ARE RESPONSIBLE FOR ANY INSTALLATION OR REMOVAL CHARGES AND FOR ANY INITIAL SHIPPING CHARGES if the unit(s) must be shipped for warranty service. However, we will pay the return shipping charges to any destination within the U.S.A. if the repairs are covered by the warranty.
3. Any unit which in the judgment of OWI Inc. is defective or develops defects under normal use will be replaced or repaired without cost within the warranty period.
4. This warranty will be considered void if unit has been dropped, misused, abused, altered in any manner, overdriven with excessive amplification exceeding manufacturer's specification, improperly serviced or accidental damage.
5. OWI Inc. shall have no liability whatsoever for consequential damage. The sole responsibility and discretion of OWI Inc. under this warranty shall be limited to the repair of the product or replacement thereof.
6. IMPORTANT: This warranty is void unless the attached card is completed and mailed to OWI Inc. within 10 days following the date of purchase. Units must be sent to OWI Inc. or to the dealer where purchased.

OWI INCORPORATED
17141 Kingsview Ave
Carson, CA 90746-1207 USA

Date Purchased: _____
Model Number: _____
Serial Number: _____

(Keep this part for your record)

-----CUT AND MAIL-----

 **OWI INCORPORATED**
17141 Kingsview Ave
Carson, CA 90746-1207 USA

LIMITED WARRANTY

Model Number: _____
 Model Name: _____
 Serial No. _____
 Date of Purchase: Month: _____ Day ____ Year _____
 Owner's Name: _____
 Address: _____
 City: _____ State _____ Zip _____
 Dealer's Name: _____ City _____ State _____
 Purchased from (please check one):
 Video _____, Electronic _____, Mailorder _____, Mass Merchandiser _____, Installer _____
 Others (please specify) _____
 Remarks: _____



OWI Incorporated

Established 1978

OWI Incorporated

17141 Kingsview Ave. Carson CA 90746-1207 USA
Tel. 310-515-1900 Fax 310-515-1606

www.owi-inc.com